

Simplified®

Simplified, for peace of mind!

User Manual : EF-SP



Scan for more help!

Security is just a touch away

Simpled®

Simplified, for peace of mind!

User Manual : EF-SP



Discover our Range of Products:

Simpled is a London-based tech company rolling out innovative IoT devices to elevate the smart home experience. Control your home with a range of smart security devices from Simpled. Whether it's a Smart Door Lock, a Camera Doorbell, Simpled put you in control of your home security.

Thank you for choosing the Simplified Slim Door Lock. Please read this manual completely before using the Simplified Slim Door Lock.

Table of Contents:

Product Overview	1
What's Included	2-3
Specification	4
Factory reset	4
Installation	
Remove the old Handle	5
Change the Handle direction	6
Compatibility Test	7-8
Step 1 Install Mortise	9
Step 2 Square Shaft	9
Step 3 Install Sliding Screw Casing	9
Step 4 Step 4 Connect Front and back Panels Wires	9
Step 5 Install Back Panel	10
Step 6 Install the Battery	10
Operation	
Setting up the Smart App	11-12
Bluetooth Unlock	12
Add fingerprints	13
Add passcodes	14
Passcode Management	14
Create and Send e-Keys	15
e-Key Management	15
Create Admin	15
Programme Card, Proximity Fobs, Phone Tag Stickers	16
Unlocking Records	16
Pair Wireless Key Fob	17
Activate Passage Mode	18
Import data from an old Simplified lock	18
How to turn off/on the lock sound?	18
Transfer lock to a new owner	18
Pairing WiFi Bridge	19
Light Status	19
Pair the Gateway with APP	19-20
FAQ	21
Want more Accessories? Here is all you want	22
Note	23-24
Contact Us	25

Please read this manual completely before fitting and using Simplified Smart Locks.

Please keep your backup keys in a safe and convenient place for peace of mind.





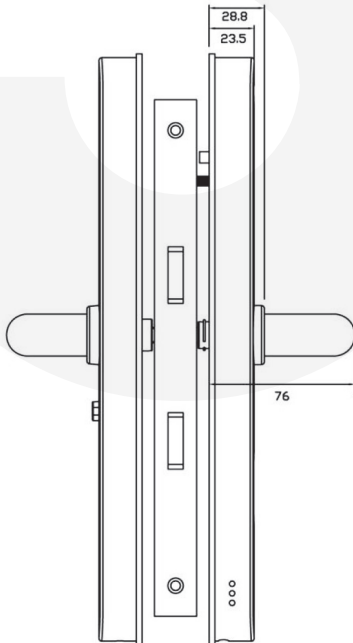
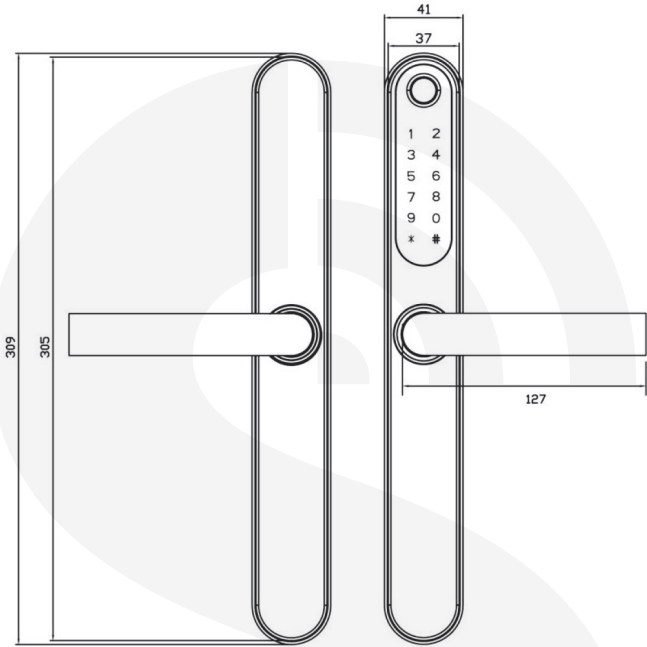

Ensure to follow the instructions to avoid any injuries or damage to your smart lock.

For more information and support on Simplified Slim Door Lock, feel free to contact us:
support@simplified.tech

Product Overview

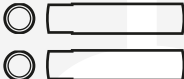

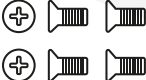
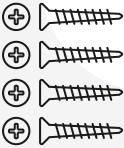
What's Included?

- 1x Spindle 80 mm 
- 1x Spindle 60 mm 
- 1x Split pin 
- 2x Screw Stubs: 30x8 
- 2x Screw Stubs: 35x8 
- 2x Sliding Screws 
- 4x Mortice Screws 10x5 mm (for Aluminum Door) 
- 4x Mortice Screws 20x4 mm (for Wooden Door) 
- 2x M5x30 mm Screw 
- 2x M5x40 mm Screw 

What's Included?



Simpled.

- 1x Phone Tag (Sticker)

Contactless Key

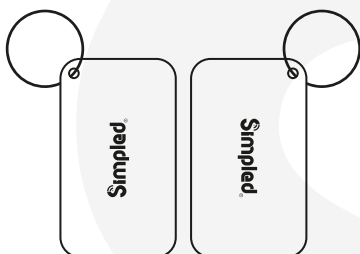

- 2x Proxy Fobs

Contactless Keys

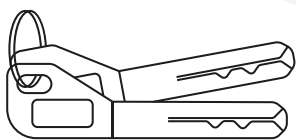

- 2x Emergency Key



- 4x alkaline battery 1.5v

- 2x Rubber Gasket

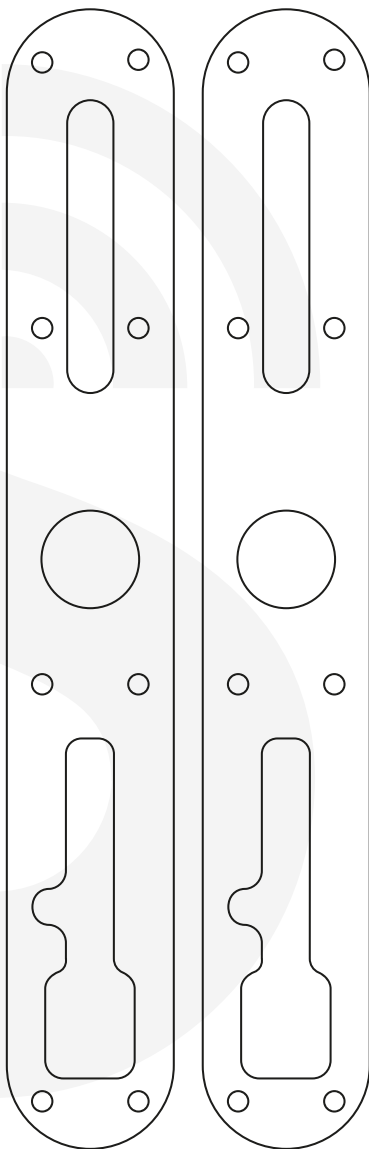

Simpled.

Specification

Model	EF-SP	Doors Applicable	Aluminium Door Wooden Door - UPVC Door
Materials	Handle: SS304 Panel: SS304	Working Voltage	6V/4 x AA Batteries
Weight	2 KG	Door Thickness	35-60 mm (For thicker doors, longer spindle and screws are needed)
Unlocking Methods	Smart phone Apple Watch Finger print Passcode Proxy Fob/Phone Tag NFC (Limited smartphones) Emergency Key Alexa (needs gateway) Google Home (needs gateway)	Data Capacity	Fingerprint: 100 RFID Cards (Fobs/Stickers): 200 Custom Passcode: 150 Auto-generated passcodes: Unlimited eKeys: Unlimited
Colour	Silver - Black	Working Temperature	-10°C-55°C
Low Battery Alarm	Less than 4.8 v	Weatherproof	Yes

System Initialisation

Reset Button



Open the cover plate of the front panel , long press the "Reset" button on the back panel for 5s, press "000#", and the initialisation is complete

Notice:

The previous passcodes, fingerprints, etc., should no longer work;
Only the initial passcode: 123456#

Replace Battery

Loosen the screws at the bottom of the rear panel clockwise

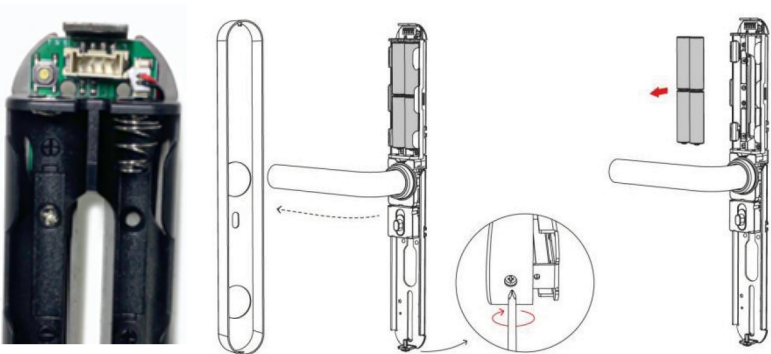

Simplified

Installation

Turn the handle

For Front Panel:

1. Turn the handle on the front panel and loosen the screws on the handle counterclockwise

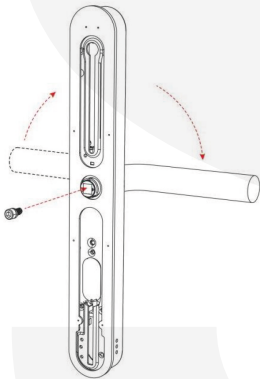
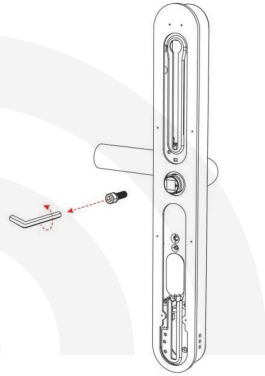

2. Remove the handle

3. After adjusting the direction of the handle insert it into the handle seat and re-lock the screw of the handle to the complete the Process

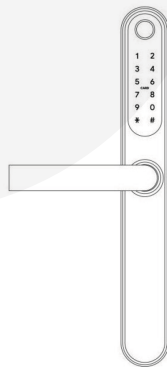

Installation

Turn the handle

For Back Panel:

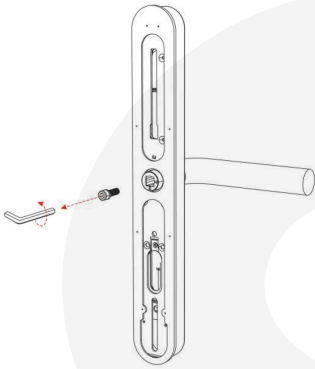

1. Turn the handle on the front panel and loosen the screws on the handle counterclockwise

2. Remove the handle

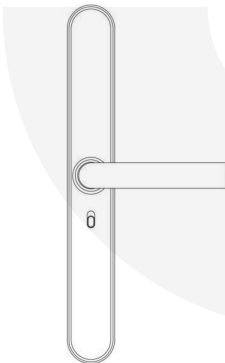
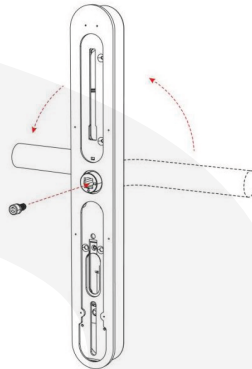

3. After adjusting the direction of the handle seat and re-lock the screw of the handle to the complete the Process

Simplified may change the functionality and design of the products without prior notice with the purpose of improving performance and quality!

Simplified

Notice: Please try this compatibility test before drilling a new hole into your door.

Compatibility Test

One test to see if the new lock is compatible with your existing multipoint locks is to check if it can fully retract the hooks and bolts on your multipoint mechanism.

Step 1:

Mark the current position of all bolts/hooks on your existing multipoint lock.

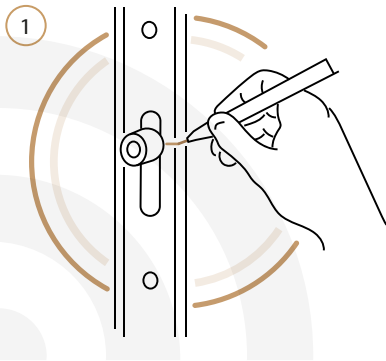

Step 2:

From the inside:

1. Locate the internal lock body on the spindle.
2. Align the lock with the door and hold it firmly.
3. Lift the handle fully to throw the bolts.
4. Done, remove it for now.

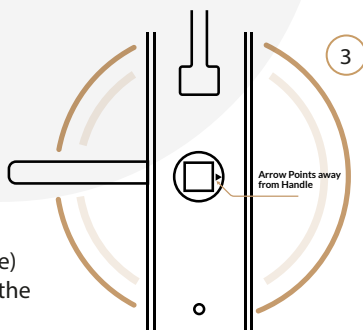

Step 3:

Take the front body(fingerprint handle) and turn the spindle receptor so that the arrow POINTS AWAY from the handle.
— "It's the opposite of what is suggested on the lock! We do this only for the test part!"

Compatibility Test

Step 4:

From the outside:

1. Locate the front body on the spindle.
2. Align the lock with the door and hold it firmly.
3. Push the handle fully downward to retract the bolts.

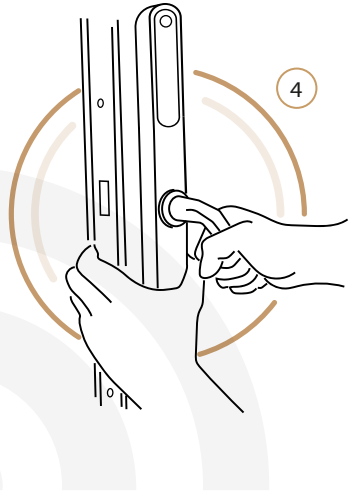

Point arrow back
to handle

Tip: You can now return the spindle receptor so that it POINTS TOWARDS the handle. It's necessary for the next steps.

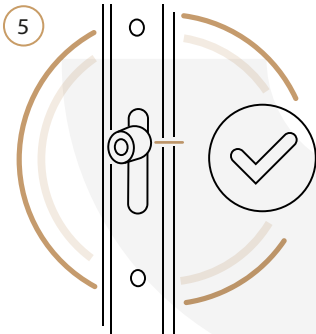

Step 5:

Now check if all bolts and hooks have fully retracted to the marked position. If bolts don't prevent you from closing the door, we successfully passed this test!

Installation

Step 1: Install Mortice

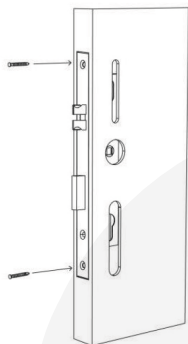

1. Insert the screw into the hole and fix it

Step 2: Install Sliding Screw Casing and Square Shaft

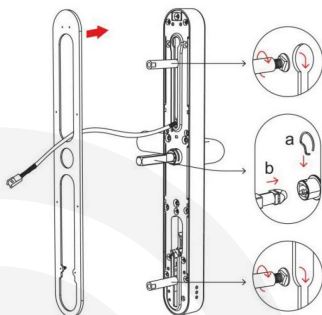

2. Choose a screw column suitable for the thickness of the door install it on the front panel
2. Install waterproof in alignment with the holes
3. Install the square shaft, put on the U-Clip. The arrow is in the same direction as the handle

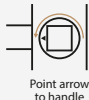

IMPORTANT: Ensure the arrow on the spindle receptor is pointing towards the handle. If the handle is in the left direction, the arrow should face the same way.

Step 3: Install Front Panel

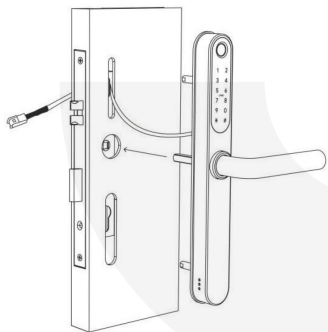

3. Align the front panel of the installed accessories with the holes of the door and install

Step 4: Install Back Panel

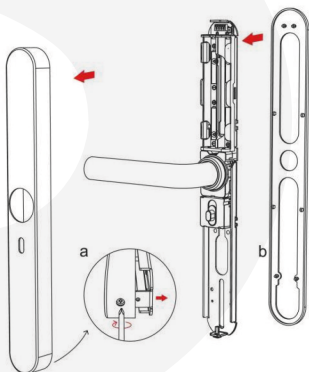

4. Install another waterproof pad to the rear panel

* When you want to drill a new hole for the cable, you might need to remove the multi-point mechanism to locate a safe spot to drill. To remove the multi-point lock, you need to unscrew several screws down its length.

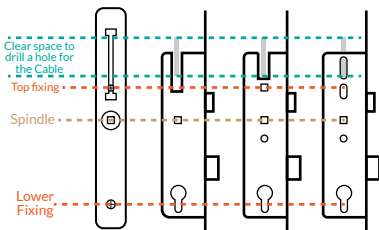

Different Multipoint lock Mechanisms

Installation

Step 5 Connect Front and Back Panels Wires

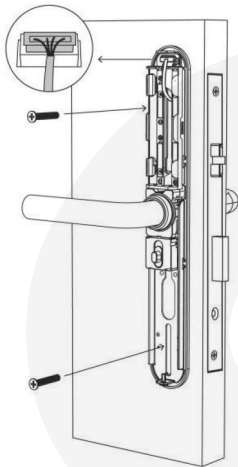

5. Fix the front and back panels with screws suitable for the thickness of the door
2. Connect the front power cord to the back panel

Step 6 Install the Battery

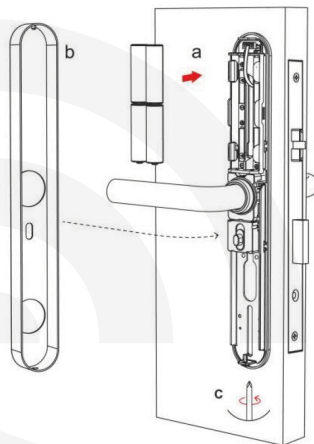

6. Install 4* AA batteries
7. Install the battery cover

Tips

Lift the handle to engage the deadbolts/hooks and then pull the handle down to disengage.
The internal handle should always open the door.

TEST: Try pulling the outer handle down. It should move but do nothing. Then insert the keys and turn. Try lifting the handle and then pull down. This time the latch/hooks should retract.

Note: Simpld Smart Lock comes with an auto-lock feature. It means the spindle doesn't engage from the outside when pushing the handle downward unless you gain access with a fingerprint, passcode, etc.

In multi-point locks, the bolts/deadbolts/hooks will engage when you lift the handles. Otherwise, the door may only be held on one latch. So it's always recommended to lift the handles to engage the multi-points.

Don't use chemicals for cleaning as it may affect the guarantee. A soft, damp cloth is best for gently cleaning without scratching the surface.

Nice Job. You have successfully installed the Simpld Smart Door Lock. You can now peel the protective film from the keypad.

Operation

Setting up the Smart App

1. Download the "TTLock App" from the App Store or Google Play by either
 - Scanning the QR code
 - Searching the "TTLock" app
2. Sign up for a TTLock account, and add the smart lock to the device list

Register

Email Phone

Enter your Email

Password

Confirm Password

Verification Code [Get Code](#)

Your password must have 8-20 characters, and include a minimum of two types of numbers, letters and symbols

Register

By Registering you agree to our Privacy Policy

Login Register

Phone number/Email

Password

Login

[Forgot Password?](#)

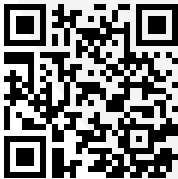

Scan for more help!

You can register an account by your email address or mobile number that is available in 200 countries around the world.

Operation

3. Activate the lock's Bluetooth by touching the Lock's keypad
4. Tap on "+ Add Lock" and select your lock type. Press on "All Locks" if you are not sure.
5. In the "Nearby Locks" list, select the appeared lock. Please make sure you are near the lock in the Bluetooth range.
6. Rename the Lock "Sweet Home, Spain Villa, London Office, ..."

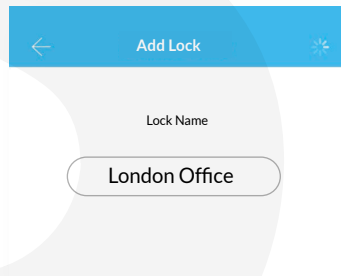
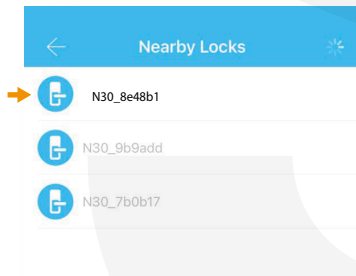
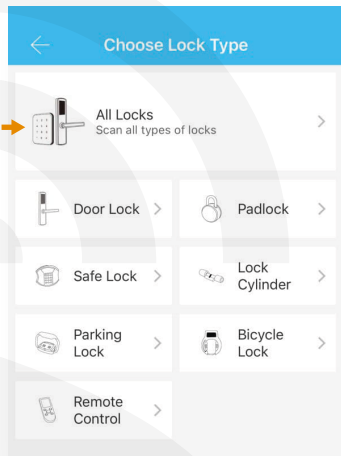
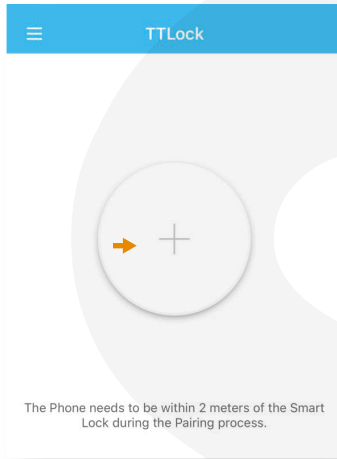

Notice: Generally, the passcode for a lock that has not yet been added is 123456

Bluetooth Unlock

Try to open the lock by tapping on the "Lock Icon". Please ensure there is no problem with Bluetooth communication, and the phone is within the 5-meter range of the Simplified Slim Smart Lock.

Add Fingerprints

For adding a new fingerprint,

1. Select Fingerprint from the lock screen in the app
2. Tap on the three dots
3. Select Add Fingerprint
4. Choose a name for later reference “ It helps you to recognise the fingerprint in the unlocking reports”.
5. Choose whether you want to create limited-time or permanent access.
6. Then start and press your fingerprint 4 times on the fingerprint sensor
7. You should see it is done successfully.
8. Test the fingerprint.

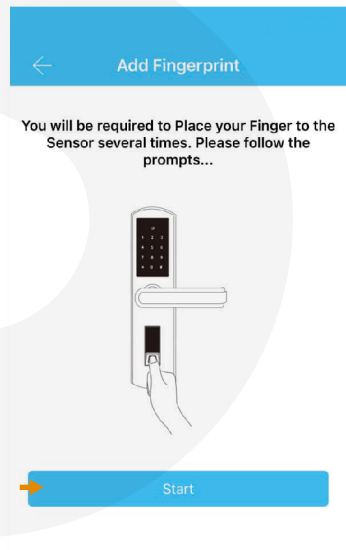
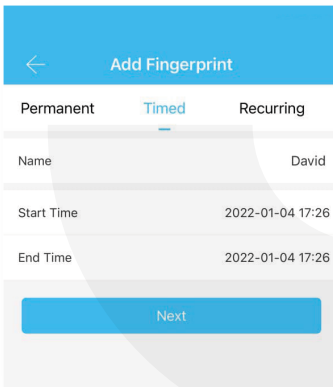
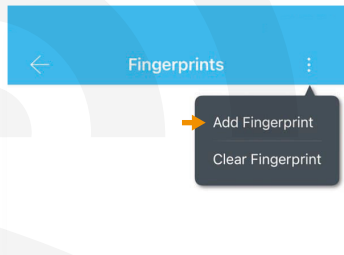
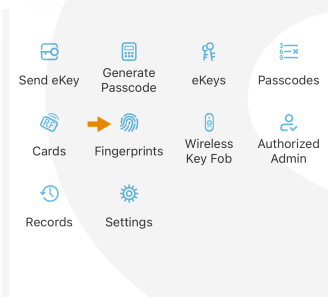

Add Passcodes

You can create different passcodes types to open the Simplified slim lock: permanent, time-limited, OTP(one-time passcode), cycle or custom. You can easily share the passcode with other users via SMS, Email, WhatsApp.

You can create, limit, share and delete a passcode without a bridge using the app when you are near the lock.

But for example, If you want to eliminate a passcode remotely, you need a Bridge. You can learn more about Bridge features in its section.

Gain access with Passcodes:

1. Touch the keypad with your palm or back of your fingers to wake up the lock.
2. Enter the generated passcode. (Before setting new passcodes, the default code is 123456#)
3. Press #.

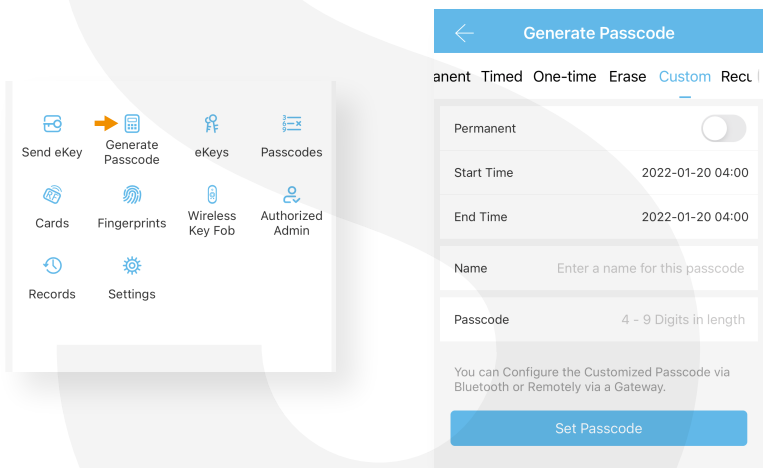

Passcode Management

Click on "Passcodes". In this section, the Admin user can

1. Change, delete or reset passcodes.
2. Review the unlock records of passcodes.

Create and Send e-Keys

By selecting the "Send eKey" as shown in the figure, you can create and share an electronic key with your friends, family, maid, dog walker or your AirBnB guests. For using the eKey, they need to download and sign up for a new account. This will also help you find out about the time they opened the lock. E-Keys are also available in different types: Permanent, Time-Limited, One-time and recurring.

You can authorise a user as Admin in the Authorised Admin section

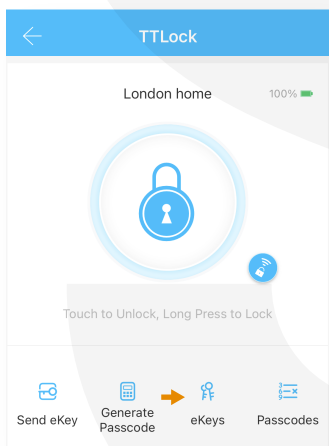
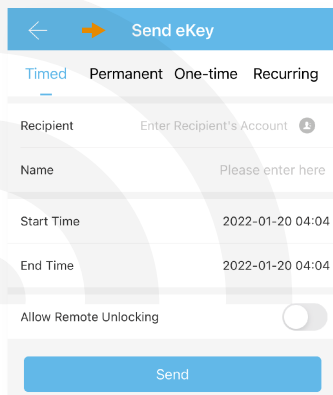
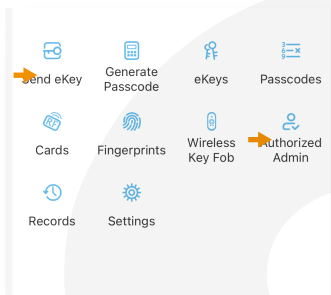

e-Key Management

Click on eKeys. In this section, the Admin user can

1. reset or delete eKeys.
2. review the access records.

Create Admin

With this feature, you can assign a new timed/ permanent admin to have the same level of access to the lock.

For example, your receptionist or even your guest will be able to add new users and even register their own fingerprint on the smart lock, up to the time their users are valid.

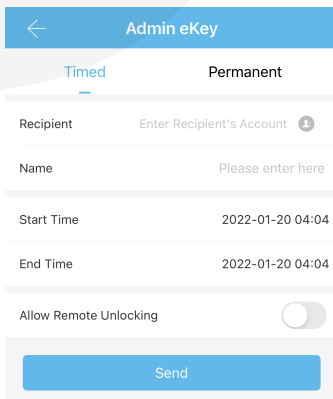

Programme Card, Proximity Fobs, Phone Tag Stickers:

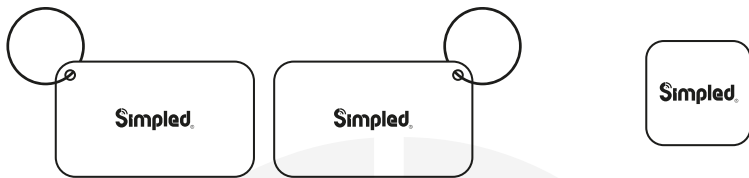

Before a proxy fob or sticker can open the lock, it is required to be programmed first. Fobs/Stickers can also be Permanent or Limited by time.

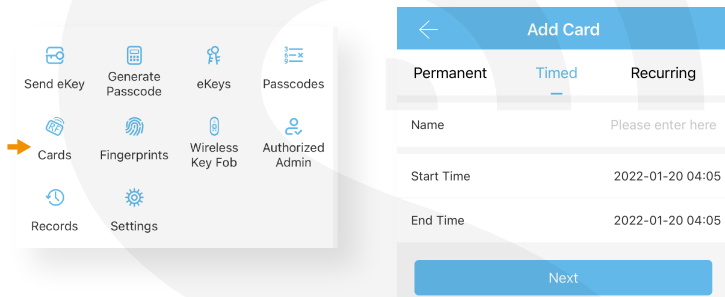

Unlocking Records

Tap on "records". In this part, you can review all the unlock records

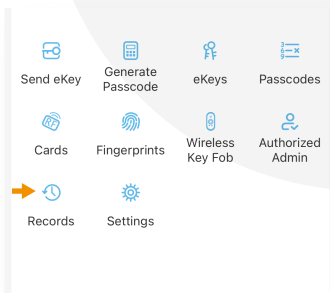

Pair Wireless Key Fob (Bluetooth Remote Controller)

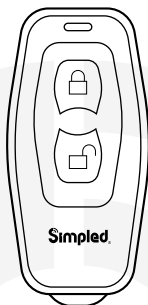

1. Tap on "Wireless Key Fob".
2. Add Key Fob
3. Use Permanent/Timed/Recurring Tab.
4. Long Press the Locking Key on the Remote controller for 5 seconds.
5. Tap "Next" when the light flashes quickly.

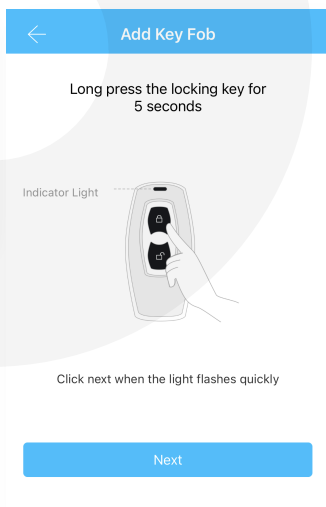
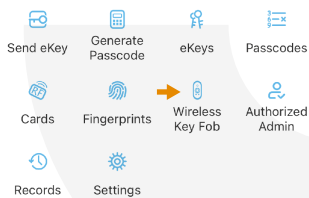

Activate Passage Mode

1. Choose the lock
2. Tap on "Settings"
3. Select "Passage Mode"
4. Turn on this mode and press Save

Note: To activate the passage mode, you need to unlock it once with the app!

When passage mode is activated, you can long-press # to force-lock the Simplified lock! It's the same when the auto-lock feature is off; you can long-press # to lock the door.

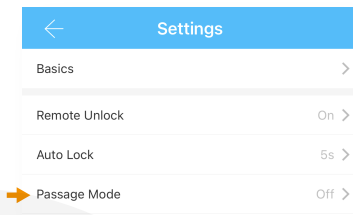

Import data from an old Simplified lock.

To transfer data from an old Simplified lock to a new one you can follow these steps:

1. Choose the new lock on the app.
2. Tap on "Settings"
3. Select "Import from another lock"
4. Choose your old lock from the list.

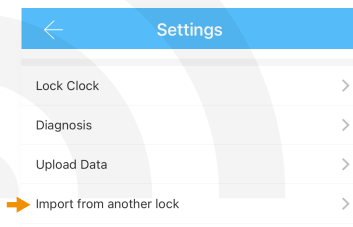

How to turn off/on the lock sound?

1. Open the app.
2. Tap on the lock.
3. Choose "Settings".
4. Disable/Enable the Lock sound.

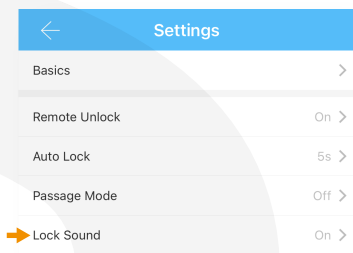

Transfer lock to a new owner

1. Open the app
 2. Tap on the  (Top Left)
 3. Select "Settings"
 4. Tap on "Transfer Lock(s)"
 5. Select the lock(s) and press Next
 6. Enter the new owner Account, and press Next.
- Notice: The selected lock(s) will be permanently transferred.

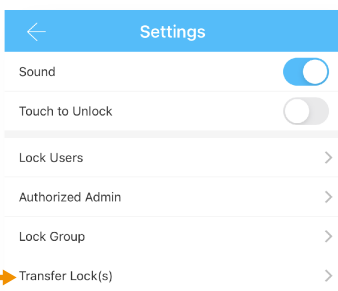
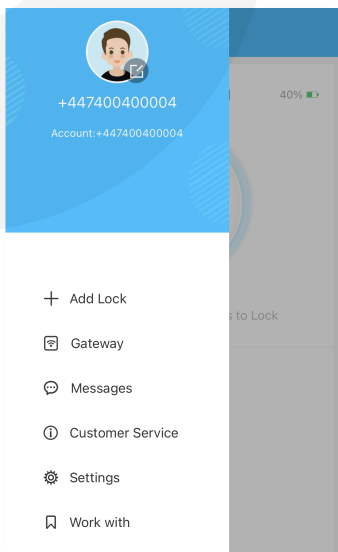

WiFi Bridge Pairing

The Simplified Smart WiFi Bridge is a bridge between Simplified Smart locks and WiFi. With the Gateway, you can

- open your lock from anywhere
- remotely read the lock operation records, including, fingerprint, passcodes
- calibrate the lock clock remotely
- remotely delete and modify passcodes
- use the Simplified lock with your Alexa
- use the Simplified lock with your Google home

Light Status

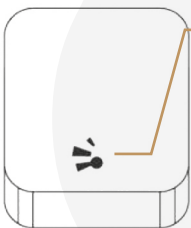

When the WiFi Bridge is power on:

- Light Flashes alternately in Red and Blue: Stand-by mode, ready for pairing
- Blue light: Working mode
- Red Light: Network failure

Pair the Gateway with APP

1 Activate the APP



2 Pres "☰"



3 Select (Gateway)



4 Select (G2)

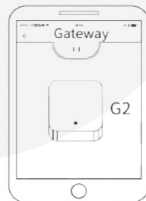

Pair the Gateway with APP

- 5 Plug in the Gateway and power it on, while the light Flashes alternately in red and blue

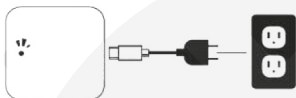

- 6 Press “+” sign



- 7 Add (Gateway) 8 Select the network and fill in the password



- 9 Add complete

Notice: If times out, please turn off and on, and try it again.

After pairing the WiFi Bridge, please turn on "Remote Unlock" on the TTlock settings.

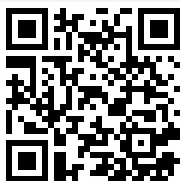

Scan for more comprehensive TTlock app manual.

Simplified

FAQ

1. Can I keep my previous multipoint lock?

We designed it to fit most existing 'lever up' multipoint mechanisms.

These are typically found on UPVC doors. So in 95% of the cases, the answer is yes.

There is no need to replace your current mortice.

Get in touch if you need more information.

Support@simpled.tech

2. I just installed the door, and although the locks verified my access, nothing happens when turning the handle from outside.

It can be because of the wrong direction in the arrow on the spindle. Please review the installation instruction (Installation Section - Installing the Spindle)

3. The spindle receptor used to rotate freely, but now it is frozen. Why?

Change the battery and try to gain access with a passcode or via the app; Now, the motor should disengage the spindle, and it should rotate freely.

4. I can not change the passcode. It says Operation failed.

First, ensure your smartphone is within 2 meters of the cylinder when setting the passcode. If it is, turn off your smartphone's Bluetooth for 10 seconds and turn it on again.

5. After installation, I touched the keypad, but there was no response. What is the reason?

A) Check if the battery is placed correctly and if it has enough power.

B) Remove the back panel and check if the cable is connected properly.

C) Unmount the lock and make sure the cables are not squeezed or damaged.

6. What's the purpose of the Auto-Lock?

To set a timer for the Smart lock to be automatically locked after each time you unlock it.

7. I had a problem registering my fingerprint.

Check if your fingerprints are clean without any dirt or wear. Clean the sensor with a soft cloth making sure there's no oil, stains, etc.

8. What is the reason the batteries ran out?

It can be due to long standby or a Short Circuit caused by a damaged cable.

9. Why can't I unlock the lock after activating the passage mode?

The lock needs to be unlocked once, and only then, the passage mode will be activated.

10. What happens if you enter the wrong password into the lock too many times?

After five failed attempts to enter your passcode, your lock will be disabled for 5 minutes. You can try other unlocking methods.

11. How can I read the operation records?

Open the app 2. Select your lock 3. Select "Records"



For the latest FAQ and support page, please scan this Code:

Simpled[®]

Want more Accessories? Here is all you want:



More accessories?
SCAN HERE

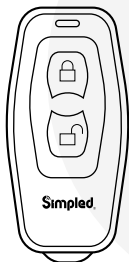

Bluetooth
Remote Controller

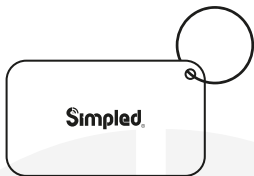

Proxy Fobs
(Contactless Key)

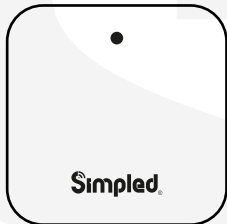

WiFi Bridge



Phone Tags
(Contactless Key)

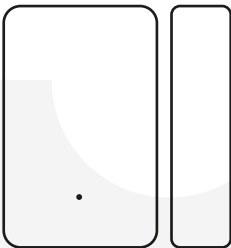

Door Sensor

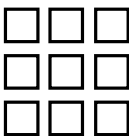

Another Smart lock
for other doors

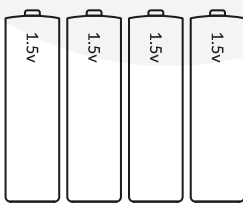

Alkaline Batteries

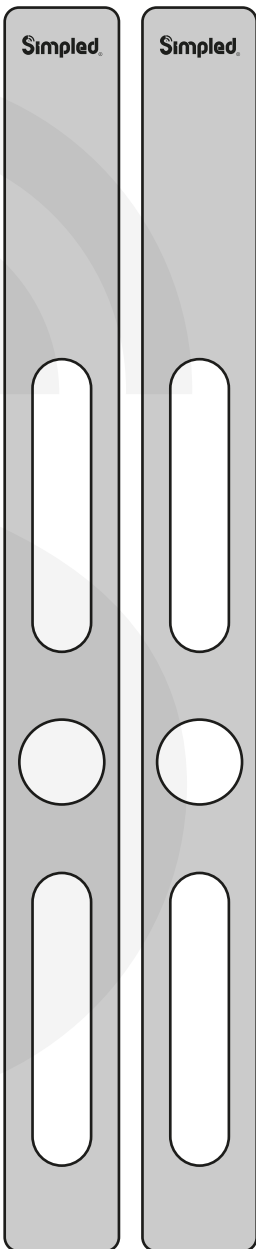

Covering Plates



Smart lock for
a friend or family



Note:

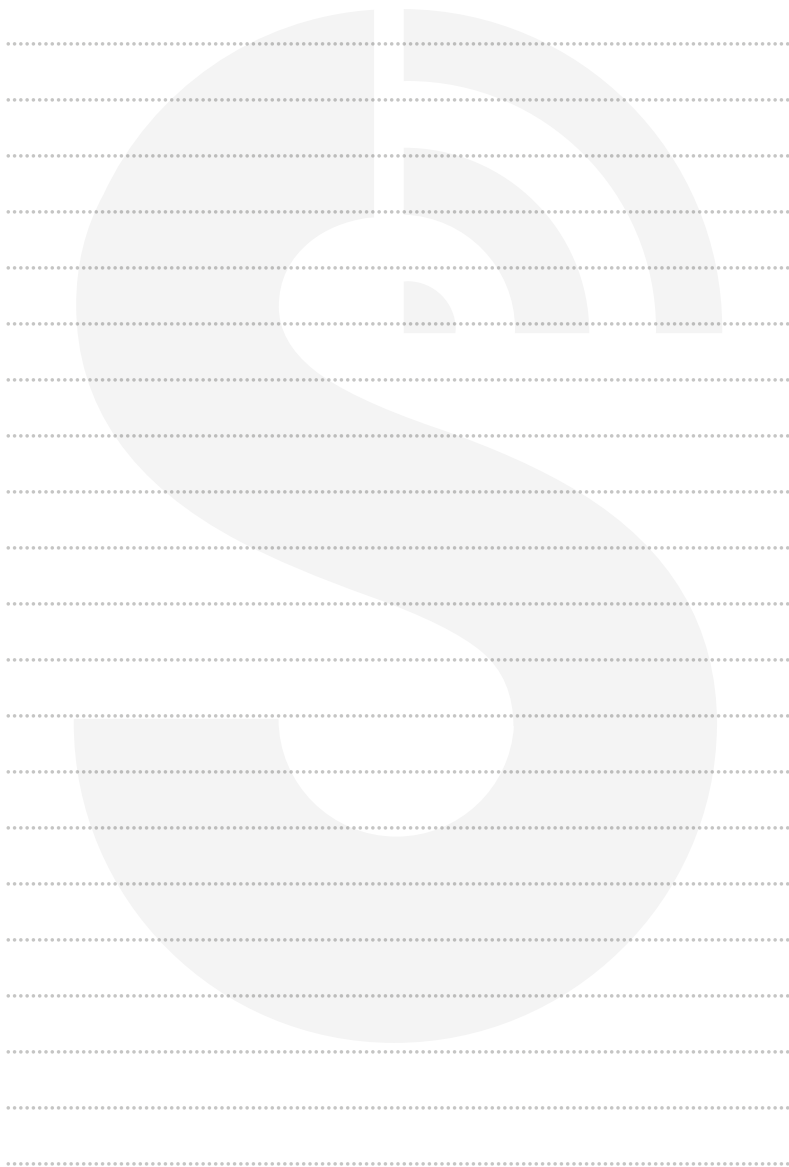

Note:

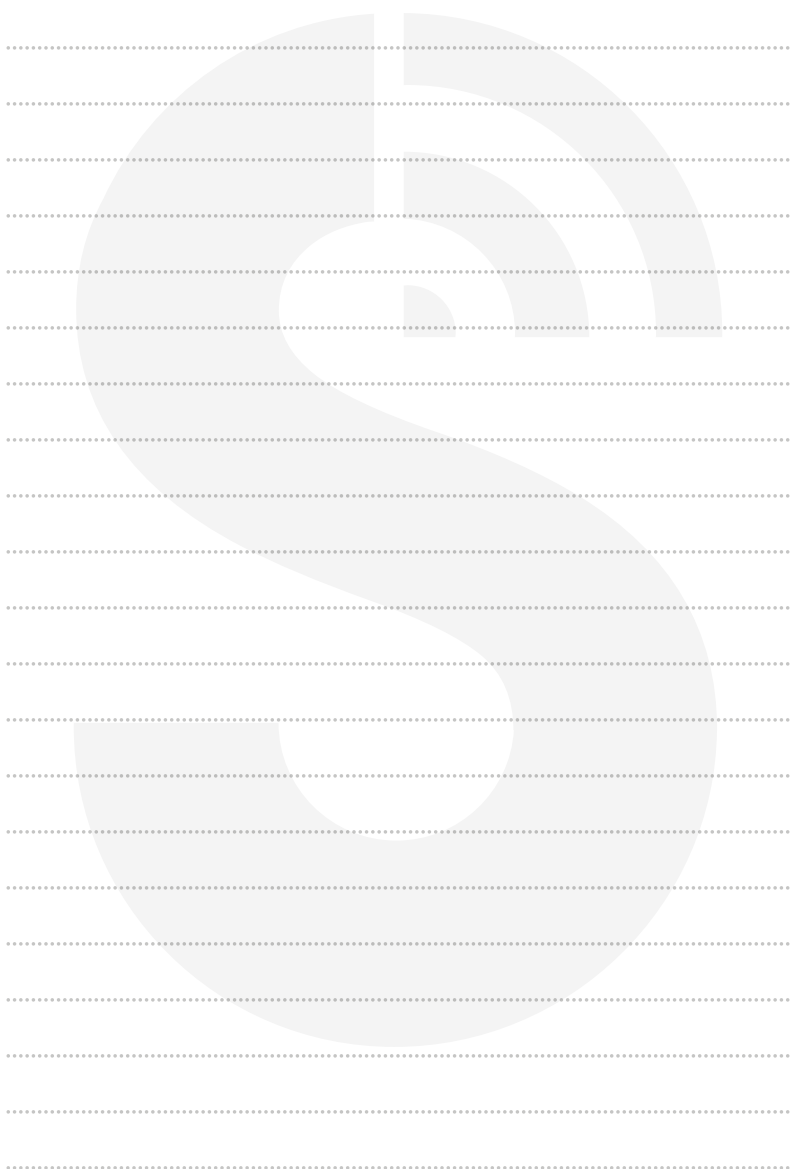

Contact us:

Note:

1. We provide you with a two-year warranty from the date of purchase.
 2. This warranty service is valid for customers in any country in the world.
 3. For more help please contact us:
Simpled.uk/support
-



WOW!

We're just happy that you're happy.
If you don't know how to express your newfound joy, we've got a few suggestions...



Tell your friends and family



Share your experience by writing a review on Amazon

OR



Connect with us on simpled.tech
Facebook, Twitter and Instagram



Easy Amazon Review
Scan me!



MEH.

Our friendly customer service team will work hard to put a smile back on your face.
Here's how we can connect:

✉ support@simpled.tech

🌐 Simpled.uk/support